

# USER MANUAL

## **Au** GOLD FINDER

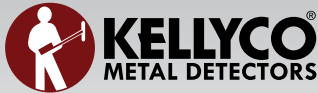

---

## READ CAREFULLY BEFORE ASSEMBLY / OPERATION OF THE DETECTOR

### LEGAL DISCLAIMERS

Comply with applicable laws and regulations governing use of metal detectors while using this detector. Do not use the detector without authorization in protected or archeological sites. Do not use this detector around unexploded ordnance or in restricted military zones without authorization. Notify appropriate authorities with details of any historical or culturally significant artifacts you find.

### PRECAUTIONS

▶ **Au GOLD FINDER** is a state-of-the-art electronic metal detector. Please read the User Manual before you assemble or operate the metal detector.

**IMPORTANT:** Do not store the detector and search coil under extremely low and high temperatures for extended periods.

▶ Detector is IP54 compliant. Do not immerse the detector (except for the search coil) in water.

▶ Protect the detector against impacts during normal use. For shipping, carefully place detector in original carton and secure with shock resistant packaging.

### WARNING

**Au GOLD FINDER** metal detector may only be disassembled and repaired by **Nokta** Authorized Service Centers. Unauthorized disassembly / intrusion into the metal detector control housing for any reason voids the warranty.

---

---

## Table of Contents

---

Assembly .....	1-3
General Description of the Device .....	4
Battery Details .....	5
Correct Use .....	6
Quick Guide .....	7
Search Modes .....	8-9
Settings .....	9-11
Ground Balance .....	12-14
Sensitivity, iSAT, Threshold and iMask .....	15-16
Sweep Speed and Target Identification .....	17
Large or Near-Surface Targets .....	17
Detector Falsing .....	17
Rocks and Detecting in Rocky Terrain .....	17-18
Detecting Highly Mineralized Ground .....	18
Tracking and Effects of Rocks .....	19
Metals Under Rocks .....	19
Overload.....	20
Technical Specifications .....	20

---

## Au GOLD FINDER Assembly

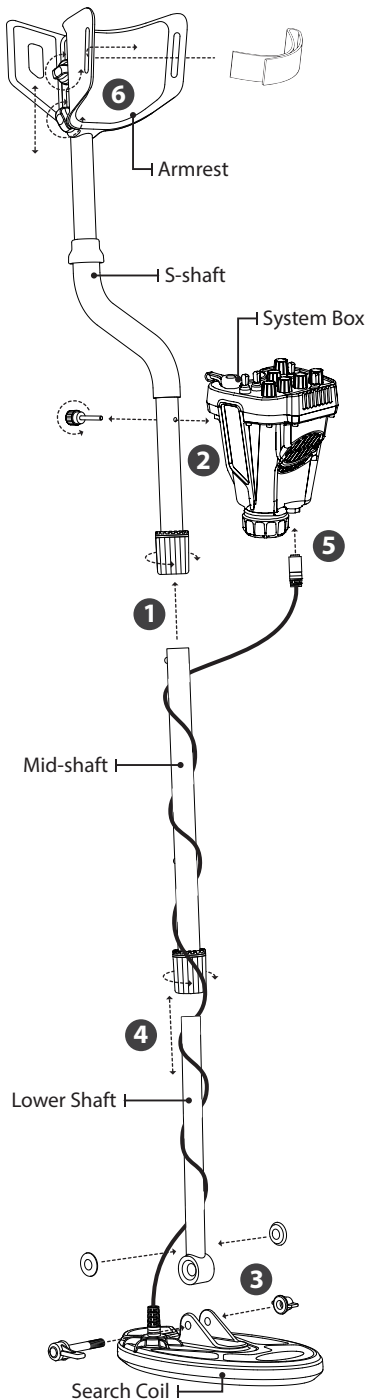

- 1** Loosen the twist lock on upper s-shaft before mounting the mid-shaft to the upper shaft. Press down the pin in mid-shaft, engage the pieces together by inserting mid-shaft into upper s-shaft being careful to align pin in shaft with alignment hole in upper s-shaft. Slightly rotate mid-shaft during insertion until pin clicks into place in upper s-shaft alignment hole and tighten the twist lock. Twist lock need only be hand tight to engage.
- 2** To attach the system box to the upper shaft, insert the thumb-screw through the hole. Then, place the thumb-screw in threaded mount point (threaded bronze plug) on underside of system box and firmly tighten.
- 3** Insert the washers on the lower shaft yoke. Carefully insert the lower shaft yoke between search coil mount tabs. Insert non-metallic lever bolt through coil mount tabs. Install and tighten non-metallic winged nut onto the threaded lever bolt and securely tighten.
- 4** Loosen the twist lock on mid-shaft before mounting the mid-shaft to the lower shaft. Press down the pin in lower shaft, engage the pieces together by inserting lower shaft into mid-shaft being careful to align pin in shaft with alignment hole in mid-shaft. Slightly rotate lower shaft during insertion until pin clicks into place in mid-shaft alignment hole and tighten the twist lock. Twist lock need only be hand tight to engage. To adjust length of metal detector shaft, simply loosen the mid-shaft twist lock and depress lower shaft spring tab. Simultaneously rotate lower shaft slightly and shorten or extend to lower shaft to desired length, re-align spring tab into desired alignment hole and retighten mid-shaft twist lock.
- 5** Carefully spool the search coil cable (do not twist or stretch) onto the lower and mid-shafts. Insert the cable connector into the system box input socket and secure by tightening the nut. Do not pull on cable when removing coil cable connector from System Box.
- 6** Insert armrest strap through its slot as shown in the figure. Adjust armrest position by loosening fasteners and sliding armrest forward / rearward to desired position and retighten fasteners.

## Au GOLD FINDER Hip Mount Installation

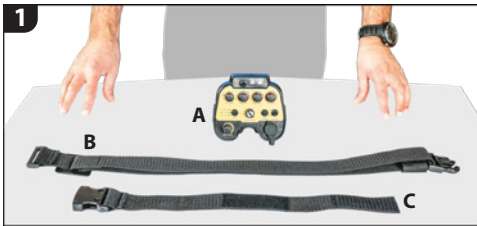

1. Before starting, you will need:

- A. Au GOLD FINDER System Box
- B. Adjustable Web Belt
- C. Web Belt with Velcro end
- D. Au GOLD FINDER Shaft Assembly with Coil attached.

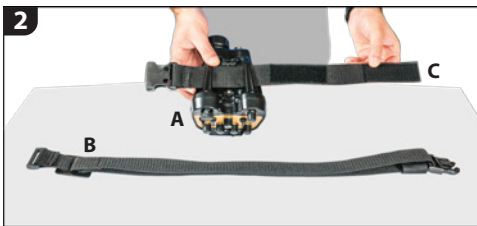

2. Begin by placing **Au GOLD FINDER** System Box on flat surface with Control Panel facing away from you underside up. Next, insert Web Belt with Velcro end (C) through belt loops molded into **Au GOLD FINDER** System Box.

**NOTE:** Right handed User should route belt left to right with Velcro side up; Left handed User should route belt right to left with Velcro side up.

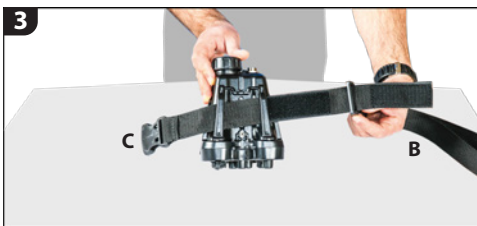

3. Insert Web Belt with Velcro end (C) through the nylon belt ring on end of Adjustable Web Belt (B) so that web belt adjustment slide is facing down. Next, center nylon belt ring on Belt (B) between male and female Velcro pads on Belt (C) and fold/secure Velcro end of Belt (C) to Velcro pad Belt (C).

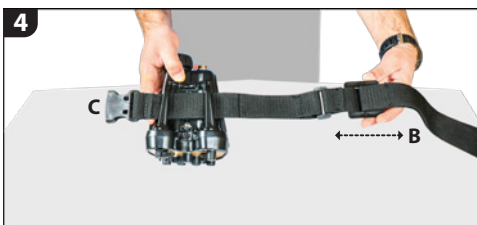

4. Web Belt adjustment slide allows belt length adjustment to fit User preference.

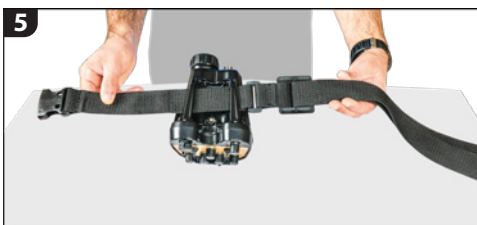

5. Lift **Au GOLD FINDER** Hip Mount Assembly and place around waist being careful not to drop or hit **Au GOLD FINDER** System Box.

## Au GOLD FINDER Hip Mount Installation

6



6. Snap Web Belt Buckle ends together. Make final web belt length adjustments as necessary to suit User preference.

7

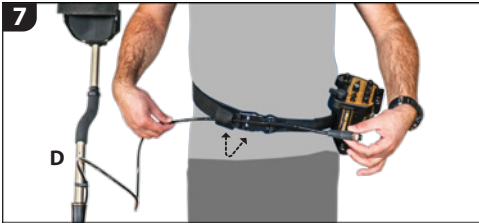

7. Insert **Au GOLD FINDER** Coil Cable through Web Belt Loop which should be positioned on Web Belt side opposite **Au GOLD FINDER** System Box adjacent to Belt Buckle.

8

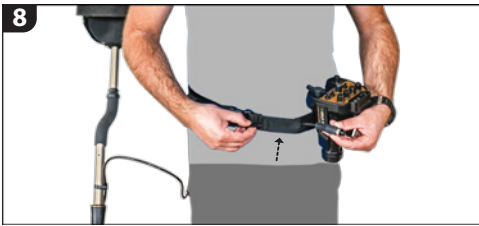

8. Insert **Au GOLD FINDER** Coil Cable through Flexible Belt Loop which is sewn into Web Belt and located adjacent to Web Belt Buckle on same side as **Au GOLD FINDER** System Box.

9

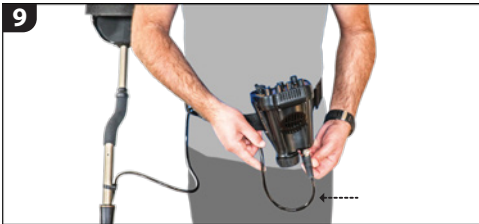

9. Pull approximately 14" of **Au GOLD FINDER** Coil Cable through the Flexible Belt Loop and attach Coil Cable Connector into System Box Cable Connector. Ensure Connectors are properly aligned and hand-tighten.

**NOTE:** Be sure to have enough Coil Cable extending through Flexible Belt Loop.

10



You are now ready to detect using the **Au GOLD FINDER**. Happy Hunting!

## General Description of the Au GOLD FINDER



## Battery Details

---

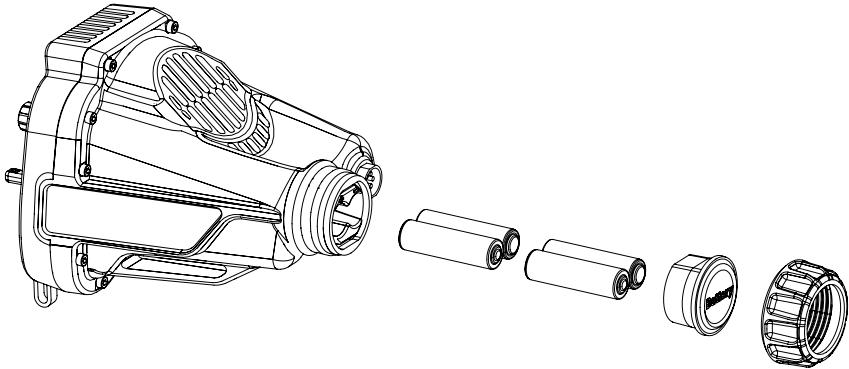

The Au GOLD FINDER is supplied with four AA Alkaline batteries.

Twist to remove the battery compartment cover (threaded ring/disc and AA battery holder). Insert the batteries into battery holder. Ensure batteries are installed properly (+ positive / - negative). Reinstall battery holder into System Box and secure with threaded ring/disc until hand tight. **Caution: Do not over tighten threaded ring.**

The Au GOLD FINDER will operate optimally for approximately 25-30 hours with the use of quality, fully charged AA batteries. Use of lesser quality AA batteries may reduce time detector optimally performs. **Caution: Do not use camera batteries or 3x/9x lithium batteries as they may damage the detector and void the warranty.**

Quality AA Alkaline batteries are recommended for the best performance. Quality Ni-MH rechargeable batteries can be used also. Rechargeable batteries with higher mAh (capacity) ratings offer extended operating times than batteries with lower mAh rating.

**NOTE: Rechargeable AA batteries are 1.2v and Alkaline AA batteries are 1.5v. Optimal performance of detector is directly related to quality and charge of batteries. Detector optimally performs with quality 1.5v Alkaline AA batteries. Do not mix batteries. All batteries installed should be the same type/rating to ensure optimal performance of metal detector.**

### Battery Status and Low Level Battery Warning

Battery status/warning: Upon initial start up, the Au GOLD FINDER will emit a number of beeps to indicate the battery status. Battery status/warning consists of five (5) levels with five (5) representing fully charged and one (1) representing nearly depleted charge status. Detector will emit five (5) beeps to indicate fully charged batteries, four (4), three (3), two (2) beeps to indicate dimishing charge and one (1) beep if the batteries are low. When the batteries are approaching full depletion, the detector will start emitting continuous beeps at short intervals indicating an immediate need to change the batteries.



# Correct Use

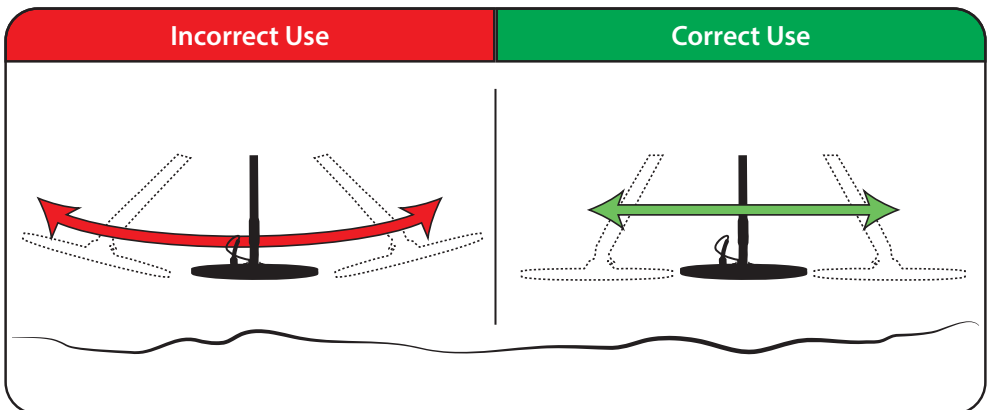
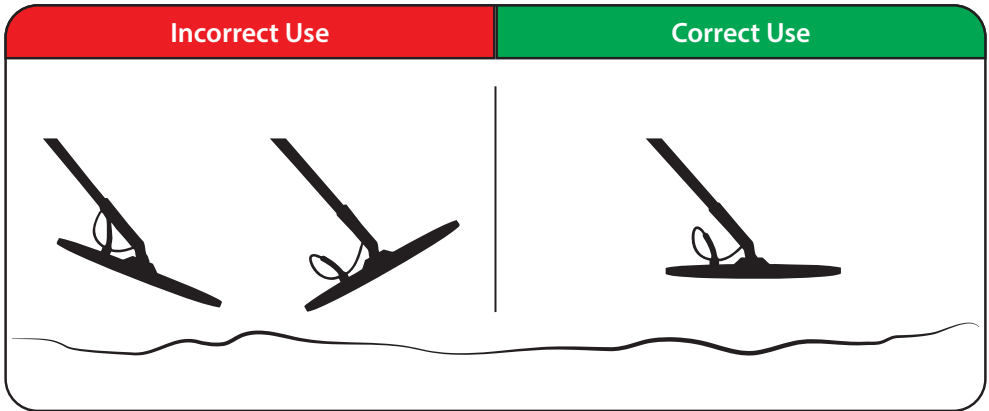
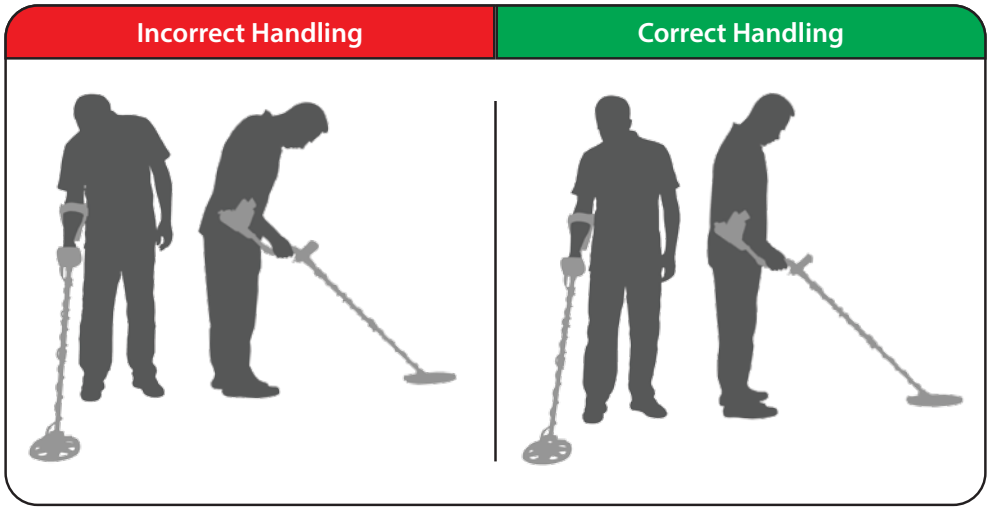

## Quick Guide

---

- 1 Assemble the detector per instructions on page 1.
- 2 Insert the batteries correctly (+/- polarity).
- 3 Rotate the Off/Volume switch clockwise to turn on the metal detector. This switch also adjusts the volume. Immediately after turning detector on, the metal detector will emit beep(s) indicating the battery life status.
- 4 Select the Mode.
- 5 Adjust the DISC. FILTER, SENSITIVITY and iSAT/iMASK switches to their default positions (highlighted numbers) on the control panel.
- 6 Auto ground balance: Depress and hold the rotary GROUND BALANCE multi-function switch and repeatedly pump the search coil up and down 3cm - 10cm (1 - 4") above the ground until detector emits a "beep" sound.
- 7 If ALL METAL mode is selected, adjust the THRESHOLD to a level where you can still hear the small nugget signals. If the metal detector receives a lot of ground noise in the ALL METAL mode causing a disruption in the threshold's stability, gradually increase iSAT value until metal detector stabilizes.
- 8 Mask/elimination of undesirable targets: When using discrimination modes (DISC.1 or DISC.2) you can eliminate (Mask) the metal detector response to undesirable targets by adjusting the DISC. FILTER value. As an example, if you are searching a trashy area filled with undesirable ferrous objects (nails) and would like to eliminate (Mask) the detector response for the undesirable target, simply sweep the detector over the target noting the response. While sweeping the detector over the target, gradually adjust the DISC.FILTER while continuing to sweep the detector until the **Au GOLD FINDER** is no longer emitting a response tone when sweeping over the target.
- 9 Sensitivity: Increasing detector sensitivity provides greater detection depth but also increases the potential instability of the detector due to high mineralization, electrical, radio frequency (RF) or electromagnetic interference. Reduce sensitivity when local environment or mineralization causes excessive noise, instability, overload and/or interferes with the optimal performance of the detector.
- 10 Tone Familiarization: Testing the detector with various metal targets using DISC.1 and DISC.2 is useful for learning the relationship between tone and specific targets.
- 11 The **Au GOLD FINDER** operates on the motion principle: If the search coil is not moving, the **Au GOLD FINDER** will not detect targets even if the coil is directly over a metal target. Sweep the search coil alternately right and left maintaining level coil at approximately 5cm (2") distance above the ground. Sweep speed should be 1.5 - 2 seconds (side to side). Sweeping the detector faster or slower than recommended sweep speed will notably diminish the performance of the detector.
- 12 Time to begin detecting!

---

## Search Modes

---

Search Modes: The **Au GOLD FINDER** has three (3) search modes, each adapted to differing ground conditions and target types. Search modes are ALL METAL, DISC.1 FAST, and DISC.2 DEEP. You can easily switch between the modes by using the MODE selector switch. For a more detailed description of these modes, please read the following explanations for each of these mode settings carefully.

### ALL METAL Mode

ALL METAL is the deepest detection mode. Different than the discrimination modes, this mode features a threshold tone which is continuously heard in the background.

ALL METAL mode detects all targets (metal, mineralized rocks, etc.) and provides a single target tone for any target detected. When ALL METAL mode is selected, the detector does not discriminate between differing target types. The volume and the tone increases in pitch as the coil is moved closer to the target.

The default values for DISC.FILTER, SENSITIVITY and iSAT will provide the best performance for a variety of ground mineralization conditions. Fine tune (adjust) these settings to account for variations ground conditions for each location being detected.

### Discrimination Modes (DISC.1 FAST / DISC.2 DEEP)

DISC modes have common performance features. They discriminate varying metal targets, but perform differently based on ground conditions in the area being detected as described below:

**IMPORTANT:** When using DISC.1 FAST and DISC.2 DEEP, sensitivity level must be properly adjusted so that the detector is silent when no metal is present under moving coil. If you hear crackling sound in DISC modes, the SENSITIVITY is adjusted too high and must be gradually reduced until no sound is heard.

No Threshold will be heard when using DISC.1 FAST and DISC.2 DEEP. The **Au GOLD FINDER** will provide audible response only when target is detected.

### DISC.1 FAST Mode

DISC.1 FAST is a 2-tone discrimination mode designed for use in gold fields with high mineralization or significant quantities of conductive hot rocks. DISC.1 FAST provides slightly less depth performance but significantly improved target detection and recovery speeds in trashy and/or highly mineralized soils when compared to the other modes.

### DISC.2 DEEP Mode

DISC.2 DEEP is a 2-tone discrimination mode designed for use in gold fields with less mineralization and/or minimal quantities of conductive hot rocks. DISC.2 DEEP provides increased depth performance and slower recovery speeds which are acceptable in minimally mineralized soils when compared to the other modes.

In DISC.1 FAST and DISC.2 DEEP modes, the **Au GOLD FINDER** will produce a low tone for iron and positive hot rocks. For all other metals, detector will produce a single tone which increases in volume and pitch as the coil approaches the target.

---

## Search Modes

---

**NOTE:** Nuggets under hot rocks may generate a low tone (iron tone) and this is totally normal.

**RECOMMENDATION:** Familiarize yourself with the **Au GOLD FINDER** audio tones by testing different metal targets and hot rocks prior to use in the field.

**RECOMMENDATION:** If you dig a target signal and locate and remove a hot rock, rescan hole to ensure there is no small gold nugget remaining.

---

## Settings

---

### ON/OFF / VOLUME Switch

Functions as the On/Off and Volume control for the **AU Gold Finder**.

### MODE Toggle Switch

Used to select each of the three search modes.

### DISC FILTER

DISC FILTER is used to eliminate undesirable targets when DISC1. FAST and DISC2. DEEP modes are selected. The default setting for DISC FILTER is ten '10' and is clearly marked on the Control Panel. Adjust DISC FILTER as needed to eliminate unwanted target responses (nails, coins, etc.).

**NOTE:** DISC.FILTER is functional in the DISC.1 and DISC.2 modes only. DISC FILTER is non-functional when ALL METAL mode is selected.

DISC FILTER enables elimination of response to undesirable targets. DISC FILTER provides User with the ability to reject mineralized rocks (hot rocks) and undesirable targets such as iron and foil which often interfere with detector response.

DISC FILTER ranges between 0-40. The factory default value (optimal starting point) is ten '10' which is clearly marked on Control Panel.

To use DISC.FILTER, first GROUND BALANCE the Au GOLD FINDER. Select one of the Discrimination modes (DISC.1 FAST, DISC.2 DEEP). Next, set the DISC FILTER to '0', then sweep the coil over the undesirable target while simultaneously and slowly turning the DISC FILTER knob clockwise until no response is heard.

### SENSITIVITY

SENSITIVITY directly affects the detecting performance (depth) of the **Au GOLD FINDER**. SENSITIVITY range is '1-10'. Default SENSITIVITY is seven '7' which is clearly marked on the Control Panel and should be adjusted according to environmental and ground conditions.

Minor adjustments to SENSITIVITY may also be effective in eliminating or reducing detector instability due to electromagnetic signals and high ground mineralization.

## Settings

---

**NOTE:** Decreasing SENSITIVITY will often resolve coil overloading due to highly mineralized ground.

**RECOMMENDATION:** Review Sensitivity, Threshold, iSAT and iMASK sections on pages 15-16.

### **THRESHOLD Dial**

THRESHOLD dial is used to adjust the background hum sound commonly referred to as the threshold sound. THRESHOLD tone is continuously heard when **Au GOLD FINDER** is operating in the ALL METAL mode.

### **iSAT / iMASK Dial**

iSAT / iMASK dial is a multifunction switch controlling iSAT settings when ALL METAL mode is selected, and alternately controlling iMASK settings when DISC.1 FAST or DISC.2 DEEP are selected. Default position for both iSAT and iMASK are calibrated at six '6' and are clearly marked on the Control Panel. Default setting of six '6' should be used and only adjusted as described on pages 15-16 of this manual.

#### **iSAT**

Optimal performance using ALL METAL mode requires a stable THRESHOLD. Changes in ground mineralization and soil structure may cause a rise or fall in the background hum. A disruption of THRESHOLD stability may result in loss of target response to certain metals such as small gold nuggets. You should only adjust iSAT to maintain the steadiness of the THRESHOLD tone. Adjustment directly affects the detector recovery speed and THRESHOLD stability.

iSAT consists of ten levels. The default level is six '6' and is clearly marked on the Control Panel. It is recommended that iSAT be increased when detector is used in high mineralization and decreased in low mineralization. For more details, please read SENSITIVITY, THRESHOLD, iSAT and iMASK section on pages 15-16.

#### **iMASK**

iMASK is used to eliminate falsing (false signals) caused by ground mineralization or hot rocks when searching in discrimination modes. Default iMASK setting is six '6'. At level one '1', iMASK is turned off.

For more details, please read SENSITIVITY, THRESHOLD, iSAT and iMASK section on pages 15-16.

### **TONE / LED Toggle Switch**

The TONE / LED toggle switch provides the User the ability to choose between audio/visual (single tone/LED) response and audio (multi-tone) response as follows:

-1 TONE LED ON provides User with single tone target response and simultaneous LED display of FERROUS (Red LED) or GOLD NON-FERROUS (Green LED) target identification;

## Settings

---

**NOTE:** Using the **Au GOLD FINDER** in 1 TONE will enable you to hear smaller gold nugget signals more clearly.

-2 TONE LED OFF provides User with two tone target response. Low tone for iron (ferrous) or hot rocks and a higher tone similar to ALL METAL target response which indicates gold and non-ferrous metal targets.

**NOTE:** The discrimination LEDs are inactive in this position and will not light up with target identification.

### **BOOST**

BOOST amplifies the weak detection response for very small or very deep targets increasing the detection probability for even the most difficult targets. BOOST should be only be used on a temporary or as-needed basis in highly mineralized ground because it will amplify threshold hum, ground noise and may contribute to increased detector falsing.

**NOTE:** BOOST works in ALL METAL mode only.

### **TRACKING**

Use of TRACKING automatically adjusts GROUND BALANCE to compensate for changes in ground mineralization while detecting.

**RECOMMENDATION:** Review the following GROUND BALANCE procedures.

---

## GROUND BALANCE

---

GROUND BALANCE can be performed three ways in **Au GOLD FINDER**: 1) Auto, 2) Manual and 3) Tracking. GROUND BALANCE is a multi-function dial (rotary and push) used to perform either Automatic or Manual GROUND BALANCE. Push and hold for setting Auto GROUND BALANCE. Rotate to fine tune Manual GROUND BALANCE. The third GROUND BALANCE option is TRACKING which is selected using the TRACKING toggle switch.

### Automatic GROUND BALANCE

Automatic GROUND BALANCE may be used in all search modes and is performed as follows:

1. Perform Automatic GROUND BALANCE procedure in location where there is no metal present;
2. While keeping search coil parallel to the ground, push and hold GROUND BALANCE dial and begin pumping the search coil up and down repeatedly from about 15 - 20cm (6"- 8") above the ground down to 3 - 6cm (1"-2") above the ground maintaining smooth, even movement of coil;
3. Continue pumping coil until detector emits a beep tone which indicates completion of GROUND BALANCE sequence. Depending on ground conditions, it typically takes about 2-4 pumps for the ground balance sequence to complete.
4. In the event GROUND BALANCE sequence described above does not result in completion beep tone, please move to another nearby location and retry GROUND BALANCE procedure. Incomplete GROUND BALANCE sequence may occur if there is metal under the search coil, the ground is too conductive (mineralized) or in rare cases if ground is non-mineralized.

**NOTE:** The **Au GOLD FINDER** will continue to ground balance and produce a beep tone for as long as you keep the dial pressed.

**RECOMMENDATION:** To ensure proper GROUND BALANCE, it is recommended that the GROUND BALANCE sequence described above be performed 2-3 times prior to use of detector.

### Manual GROUND BALANCE

Manual GROUND BALANCE should be used when **Au GOLD FINDER** will not complete Automatic GROUND BALANCE sequence.

Conditions which may interfere with, or not suitable for the Automatic GROUND BALANCE sequence to successfully complete include wet beach sands, soils/sands containing alkali, salt or brine water, lands with high waste metal content (dump sites), recently plowed fields, recently fertilized fields, highly mineralized grounds and grounds with very low mineralization.

**NOTE:** Manual GROUND BALANCE requires a skill which develops over time through practice and experience. Once mastered, it becomes the preferred method for professional detectorists.

## GROUND BALANCE

---

### Directions for Manual GROUND BALANCE:

1. Select ALL METAL mode;
2. Perform Manual GROUND BALANCE procedure in location where there is no metal present;
3. While keeping search coil parallel to the ground, begin pumping the search coil up and down repeatedly from about 15 - 20 cm (6" - 8") above the ground down to 3 - 6 cm (1"-2") above the ground maintaining smooth, even movement of coil.
4. Carefully listen to THRESHOLD sounds as you raise and lower the coil during pumping action noting any changes in sound during either the raising or lowering of coil. If the sound increases as the coil is raised away from the ground, the GROUND BALANCE value is too low and should be gradually increased until the THRESHOLD sound stabilizes with no noticeable difference in sound as coil is raised and lowered. If the sound increases as the coil is lowered towards the ground, the GROUND BALANCE value is too high and should be gradually lowered until the THRESHOLD sound stabilizes with no noticeable difference in sound.

The GROUND BALANCE dial turns clockwise and counter-clockwise infinitely. We recommend that you turn the GROUND BALANCE knob slowly to be able to follow minute changes in the ground response. Again, you will gradually gain skill at Manual GROUND BALANCE through experience.

**NOTE:** GROUND BALANCE may not completely eliminate ground interference in some areas. In these rare instances, carefully listen to the sounds produced when moving the search coil towards and away from the ground to check if the GROUND BALANCE is correct (i.e. slight sound is consistent when moving coil towards and away from ground). If sounds are consistent, GROUND BALANCE is set properly.

**RECOMMENDATION:** Experienced detectorists using the **Au GOLD FINDER** when manually adjusting the GROUND BALANCE setting to provide slight positive response (very weak but audible sound when moving the search coil towards the ground). This method may produce favorable results for experienced Users in certain fields where small gold nuggets are searched for.

### TRACKING

-TRACKING automatically updates **Au GOLD FINDER** GROUND BALANCE as the search coil is swept over the ground.

-TRACKING does not provide audio feedback (tone) to the User when selected.

-TRACKING feature is activated by switching the TRACKING switch to the "ON" position.

-TRACKING should be used in ALL METAL mode and not recommended for use in DISCRIMINATION modes.

-TRACKING does not require any User adjustments.



---

## GROUND BALANCE

---

**NOTE:** Au **GOLD FINDER** may produce similar responses when detecting over significantly changing ground mineralization, hot rocks or targets. In order to identify a target response, simply sweep the search coil over the target location. If the response dissipates, fluctuates or changes, detector is likely responding to changing ground conditions (mineralization or hot rocks). If the detected response remains constant, it is likely a quality target and worth investigating (digging).

**IMPORTANT:** Ensure that TRACKING is turned off when conducting air tests. Failure to turn off TRACKING during air testing will result in detector continually performing GROUND BALANCE sequence during air test and result in significant depth loss as you resume detecting.

### Important Details Concerning Ground Balance

Automatic GROUND BALANCE may fail to sequence in the following conditions:

- Metal under search coil when attempting Automatic GROUND BALANCE;
- Ground is too conductive;
- Ground mineralization is too low.

Should Automatic GROUND BALANCE sequence fail to complete, please do the following:

- Change GROUND BALANCE location, repeat Automatic GROUND BALANCE sequence;
- Change to Manual GROUND BALANCE if changing location does not allow Automatic GROUND BALANCE sequence to successfully complete;

Should Automatic and Manual GROUND BALANCE attempts fail, continue detecting without GROUND BALANCE as follows:

- Restart **Au GOLD FINDER**;
- Sweep search coil over ground listening carefully for changes in tone as you sweep;
- If you hear a sound as you sweep coil over the ground, switch **Au GOLD FINDER** to either DISC.1 FAST or DISC.2 DEEP;
- Adjust DISC.FILTER gradually while sweeping coil to eliminate any sound;
- Once sound has been eliminated, proceed to use **Au GOLD FINDER**.

- GROUND BALANCE will remain stable and does not require adjustment once successfully attained (Automatic or Manual).

**NOTE:** DISC FILTER is not active when ALL METAL mode is selected;

---

## **SENSITIVITY, THRESHOLD, iSAT, iMASK**

**IMPORTANT:** SENSITIVITY, THRESHOLD, iSAT, iMASK are critical settings and must be adjusted properly to ensure noise-free optimal detector performance. Factory default positions for each of these settings are marked on Control Panel and offer the User a baseline starting point for detector use in the field. These settings should be adjusted according to local ground and environmental conditions in order to maximize detection performance.

## **SENSITIVITY, THRESHOLD, iSAT - ALL METAL Mode**

In ALL METAL mode, THRESHOLD (continuous background humming sound) should be adjusted to be 'minimally audible'. Improperly adjusted THRESHOLD can mask the signal of smaller and deeper targets (due to their low audible response) as they are lost in the THRESHOLD hum.

**IMPORTANT:** GROUND BALANCE the **Au GOLD FINDER** prior to detecting in ALL METAL mode. Failure to properly GROUND BALANCE the detector when using ALL METAL mode will result in falsing and/or disruption in THRESHOLD stability as the detector responds to ground mineralization which would otherwise be cancelled out with proper GROUND BALANCE.

iSAT adjusts the speed that the detector recovers its THRESHOLD hum and negates the effects of mineralized soils.

**IMPORTANT:** iSAT adjustments should be carefully applied to attain detector stability as any increase in iSAT results in loss of detection depth.

**RECOMMENDATION:** Should highly mineralized conditions cause detector falsing and/or disruption in THRESHOLD hum, lower the SENSITIVITY to regain detector stability. This should be accomplished prior to increasing iSAT. Should you be unable to regain stability by reducing SENSITIVITY below default seven '7'; reset SENSITIVITY to default position prior to increasing iSAT.

In low mineralization conditions, decrease iSAT and slow coil sweep speed to enhance detector detection depth.

In ALL METAL mode, SENSITIVITY behaves similar to THRESHOLD with one important difference, having too much SENSITIVITY can result in falsing and/or popping sounds.

- Detector is calibrated to be very sensitive to small gold targets;
- Ground mineralization may cause detector overload;
- Adjust SENSITIVITY to a point where detector is unstable and reduce slightly to optimize SENSITIVITY setting without negatively impacting detection performance (ex. Detector stability is the same at SENSITIVITY '5 - 8' and unstable at '9'; reduce to '8' and proceed to detect);

Factory default SENSITIVITY setting is '7' and will provide User an effective SENSITIVITY setting for most mineralization/environmental conditions.

---

-If detector is stable but too noisy (loud), THRESHOLD should be decreased;  
-If detector is unstable (falsing and/or popping), SENSITIVITY should be decreased;  
-If detector is unstable (falsing and/or popping) after reducing SENSITIVITY, reset SENSITIVITY to its default position and make minimal increase adjustment to iSAT until detector stability is attained.

## **Sensitivity in Discrimination Modes**

In DISCRIMINATION modes, THRESHOLD is not functional. SENSITIVITY is used to fine tune detector stability for changes in ground mineralization and directly affects detection depth and noise free detector operation.

**SENSITIVITY fine tuning** (DISCRINATION modes):

- Set SENSITIVITY to default setting '7';
- Set DISC FILTER to default setting '10';
- Complete GROUND BALANCE procedure;
- Sweep search coil level above ground with no metal present at 3 - 6 cm (1" - 2") as if detecting;
- Reduce SENSITIVITY gradually to eliminate any falsing and/or popping while sweeping search coil.

iMASK eliminates the effects (falsing and/or popping) which are present when detecting over hot rocks and/or highly mineralized ground while using DISCRIMINATION modes. The calibrated range of iMASK is '1 - 6' ('1' iMASK Off - '6' iMASK Max). There is no change in iMASK settings '6 - 10'.

## **iMASK in Discrimination Modes**

iMASK is used to eliminate or minimize false signals resulting from detecting highly mineralized soils or hot rocks when using DISCRIMINATION modes.

iMASK has a functioning range between '1' and '6'. Selection of iMASK levels above '6' (i.e. '7' - '10') are factory calibrated at level '6' and will not further improve masking.

iMASK default setting is level '6' as indicated on Control Panel. This provides maximum masking of ground interference often experienced in highly mineralized soils. Selection of level '6' will provide User with the ability to significantly minimize or eliminate detector falsing (false signals) which often occurs when detecting over highly mineralized ground.

**IMPORTANT:** Default iMASK setting of '6' will result in the inability for the **Au GOLD FINDER** to detect and respond to very conductive metals such as copper.

**RECOMMENDATION:** **Au GOLD FINDER** is extremely sensitive to conductive metals such as copper, micro-jewelry and coins. When using the **Au GOLD FINDER** to detect for mineralized copper, micro-jewelry, coins and other highly conductive metals, it is recommended that you set iMASK to '1'.

---

## Sweep Speed and Target Identification

**Au GOLD FINDER** detector has an extremely fast recovery speed which is necessary for detecting in highly mineralized grounds, areas with hot rocks and/or trashy areas.

To maximize the advantages of the fast recovery speed of the **Au GOLD FINDER**, you should make wide, sweeping passes of coil over the ground being searched instead and minimize narrow, quick side-to-side sweeps.

Sweep speed of the **Au GOLD FINDER** is extremely important for accurate target identification and response. It is recommended that a single sweep (left to right) take between 1 and 1.5 seconds with a complete left-right-left sweep lasting not less than 2 seconds.

Ensure coil is maintained level over the ground throughout entire sweep keep coil approximately 2" over the ground avoiding contact with rocks and ground.

## Large or Near-Surface Targets

The **Au GOLD FINDER** is exceptionally sensitive to very small, fine gold targets.

**IMPORTANT:** Large targets and targets near ground surface can result in audible overload. This overload tone resembles a continuous siren sound. When you hear this tone, simply raise the coil and continue sweeping the area. This will allow the **Au GOLD FINDER** to recover from overload, process target and provide proper response.

## Detector Falsing

Falsing is the detector response to undesirable effects such as high ground mineralization, hot rocks and electromagnetic interference including use of detector in close proximity to other metal detectors.

Most falsing can be controlled by simply reducing SENSITIVITY and/or THRESHOLD values until falsing is minimized or eliminated. Please read and become familiar with information provided in this manual for adjustment of GROUND BALANCE, SENSITIVITY, THRESHOLD, iSAT and iMASK.

Another type of falsing is the detection of an apparent desirable target with no target located. This type of falsing is very common when detectors are used in areas containing rusting or corroding iron, nails, etc. in the soil. The corrosion of ferrous metals (oxidation) creates a 'halo' of oxides around an undesirable target (i.e. nail) resulting in false or falsing response. The object may have totally decomposed into an oxidized state and when attempting to dig the target, nothing is found. You do not want to eliminate this type of falsing as you may be masking small, fine desirable targets.

## Rocks and Detecting in Rocky Terrains

**Hot Rocks:** It is important to understand that mineralized stones, rocks, cavities in the ground being searched and/or mineralization of the ground itself can significantly influence **Au GOLD FINDER** target response.

---

After the **Au GOLD FINDER** has been properly GROUND BALANCED, it will respond to hot rocks (as either negative or positive) when compared to the ground/soil where GROUND BALANCE was performed. The negative/positive effects described above will only be valid if the GROUND BALANCE is properly completed.

ALL METAL mode target response: Positive rocks act just like metal and produce a “zip-zip” sound when the search coil is swept over them. Negative rocks produce a long “boing” sound when the search coil is moved over them.

DISCRIMINATION modes target response: Positive rocks provide a typical metal response in DISCRIMINATION modes.

Negative rocks do not provide a sound in DISCRIMINATION modes when **Au GOLD FINDER** is properly GROUND BALANCED. Negative hot rock may cause slight falsing response in DISCRIMINATION mode if detector is slightly out of GROUND BALANCE. This can occur due to ground mineralization changes with TRACKING off.

## Detecting Highly Mineralized Ground

Highly Mineralized Ground: Highly mineralized ground (conductive/magnetic) can be very challenging to the User for keeping any detector properly tuned. The **Au GOLD FINDER** addresses these challenges through the incorporation of iSAT and iMASK. This exceeds the industry standard (ALL-METAL/DISCRIMINATION, GROUND BALANCE, SENSITIVITY and THRESHOLD).

**IMPORTANT:** Keeping the **Au GOLD FINDER** properly ‘tuned’ over highly mineralized ground is made possible by User selection of the best operating mode (i.e. ALL-METAL/DISCRIMINATION modes). It is important for the User to understand how to properly GROUND BALANCE the detector and make fine tuning adjustments using iSAT, iMASK, SENSITIVITY and THRESHOLD settings.

In ALL-METAL mode using higher settings of iSAT, there will be no change in the **Au GOLD FINDER** response to positive or negative hot rocks. When the iSAT value is decreased, the sound of positive hot rocks will remain the same. Negative hot rocks may give a thinner ‘beep’ sound instead of the ‘boing’ sound.

**IMPORTANT:** User knowledge and understanding of the **Au GOLD FINDER** response tones and their relationship to tuning adjustments comes with field experience.

When the **Au GOLD FINDER** emits a metal response tone, it indicates the detection of a positive hot rock or a piece of metal. As you gain experience with the **Au GOLD FINDER**, it is recommended the User dig all targets when a metal response tone is received.

---

## Tracking and Effects of Rocks

When the TRACKING is active, the **Au GOLD FINDER** may produce a response when passing over hot rocks. This response is due to magnetic/ferrous differences between the hot rock and surrounding ground. As you verify the target (repeatedly sweep the search coil over a potential target) and the target response disappears or significantly reduces, TRACKING has automatically adjusted GROUND BALANCE to eliminate the undesirable target.

TRACKING continually adjusts GROUND BALANCE as you detect. If you are detecting an area with many hot rocks, the **Au GOLD FINDER** may not respond as TRACKING repeatedly senses the hot rocks and continually fine tunes (eliminates) the undesirable targets. If you are detecting an area and infrequently encountering a hot rock, the **Au GOLD FINDER** may respond to additional hot rocks since TRACKING is continually adjusting to changing ground mineralization.

TRACKING is recommended for use in areas with changing soil types and should not be used simply to eliminate hot rocks as its use does impact detector performance (depth).

TRACKING does not eliminate metal targets. Consistent strong response when repeatedly sweeping over a target indicates high probability of metal.

**NOTE:** Because of the slight delay in TRACKING, **Au GOLD FINDER** may initially produce a strong target response (i.e. one or two sweeps) as TRACKING fine tunes GROUND BALANCE, response to undesirable target becomes weaker and disappears.

## Metals Under Rocks

**Au GOLD FINDER** can easily detect metal targets under mineralized rocks with proper adjustment of settings.

In DISCRIMINATION modes, the key to detecting targets under mineralized rocks (particularly positive rocks) is the proper adjustment of DISC FILTER.

For example, if the hot rocks in your search field can be detected when DISC FILTER is set to five '5', you should then set the DISC FILTER to six '6'. This enables a response for desirable metal targets while eliminating response to hot rocks.

**NOTE:** If you set the DISC FILTER too high, you will lose response for hot rocks and desirable targets.

**IMPORTANT:** The combined response created by the rock and metal target is lower than the response of the desirable metal target by itself. In other words, detector response to a small gold nugget under a mineralized rock may generate an iron response (i.e. low iron tone instead of high gold/non-ferrous tone).

---

## **Overload**

Large targets and targets near ground surface can result in audible overload. This overload tone resembles a continuous siren sound. When you hear this tone, simply raise the coil and continue sweeping the area. This will allow the **Au GOLD FINDER** to recover from overload, process target and provide proper response. If the response continues along a straight line in the ground, it may indicate you are over a long metal object such as an iron pipe.

The **Au GOLD FINDER** is an extremely sensitive detector and overload can result if the SENSITIVITY is set too high. Simply reduce SENSITIVITY to eliminate overload when other factors (large, near surface targets) have been eliminated as the cause of overload.

---

## **Technical Specifications**

---

Operating Principle	: VLF Induction Balance
Operating Frequency	: 56 kHz
Search Modes	: Three modes (ALL METAL/DISC.1/DISC.2)
Discrimination	: AUDIO / LED
Ground Balance	: Automatic / Manual / Tracking
Sensitivity Range	: 1-10
Discrimination Filter Range	: 0-40
Audio Boost	: Available
Search Coils	: AU26 (26x14cm (10"x5.5")) & AU13 (13cm (5")) Waterproof DD
Weight	: 1.5 kg (3.3 lbs.) including search coil and batteries
Length	: Adjustable 120cm - 140cm / 47- 55"
Battery	: Four AA alkaline
Warranty	: Two year

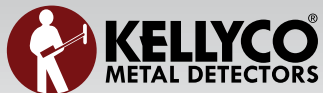

1085 Belle Avenue Winter Springs, FL 32708 U.S.A

U.S. Toll-Free: 1-888-535-5926

Others: +1 407-699-8700

[www.kellycodetectors.com](http://www.kellycodetectors.com)